

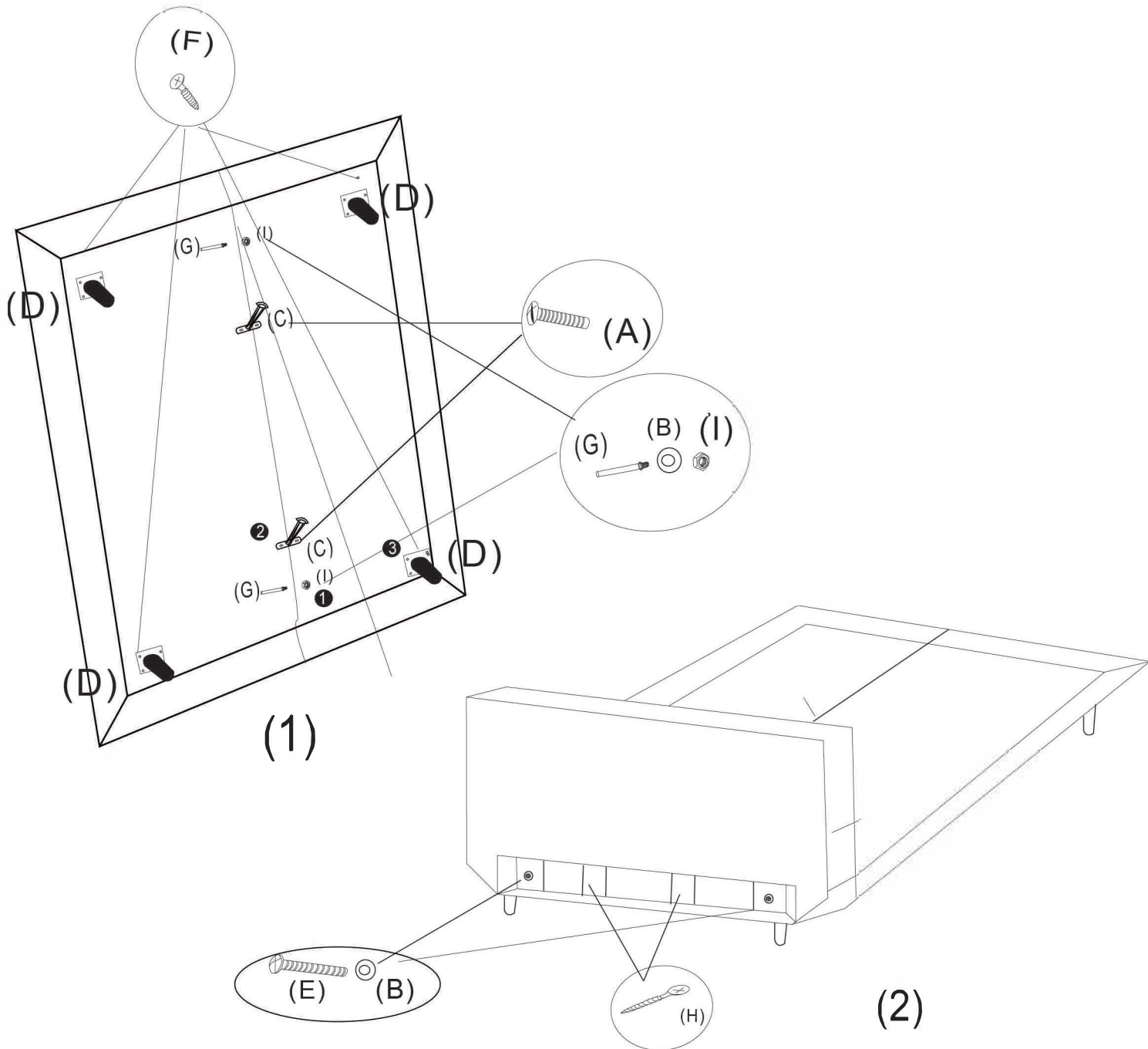









Model: cloud



Components/QTY		Components/QTY		Components/QTY	
Screw(Bedframe)	 (A) 4	Screw(Bedframe)	 (E) 2	Nut(Bedframe)	 (I) 4
Meson(Bedframe)	 (B) 4	Screw(Legs)	 (F) 16		
Legs(Bedframe)	 (C) 2	Screw2	 (G) 2		
Leg	 (D) 4	Screw(Legs)	 (H) 2		